



Storm Tide Resilient Building Guidance

for Queensland Homes

Get Ready Queensland

Preparing for a stronger, more Resilient Queensland



bushfire&natural
HAZARDSCRC



Document details

Security classification	Public
Date of review of security classification	December 2019
Authority	Queensland Reconstruction Authority
Author	Chief Executive Officer
Document status	Final
Version	1.0
QRA Reference	QRA 2635

More information

Visit www.qra.qld.gov.au/Resilient-Homes

Contact the Queensland Reconstruction Authority on 1800 110 841

Mailing address

Queensland Reconstruction Authority
PO Box 15428
City East Q 4002

Alternatively, contact the Queensland Reconstruction Authority by emailing: info@qra.qld.gov.au



Do you need an interpreter?

If you need an interpreter to assist you in understanding this document, please call **13 QGOV (13 74 68)**.

Licence

This material is licensed by the State of Queensland under a Creative Commons Attribution (CC BY) 4.0 International licence.

To view a copy of the licence visit:
www.creativecommons.org/licenses/by/4.0/

The Queensland Reconstruction Authority requests attribution in the following manner:
© The State of Queensland (Queensland Reconstruction Authority) 2019.

Information security

This document has been classified using the Queensland Government Information Security Classification Framework (QGISCf).

Introduction

Living with natural disasters is a part of life in Queensland. From time to time we experience tropical cyclones, severe storms and flooding, and as a community we need to be informed, ready and resilient.

Incorporating resilient building design can significantly reduce the effort, cost and time to return people to their homes and workplaces following natural disasters. It is one of the many ways Queenslanders can build their resilience to natural disasters.

The *Storm Tide Resilient Building Guidance for Queensland Homes* (Guide) provides information about improving the resilience of new and existing Queensland homes in storm tide prone areas.

The benefits of resilient design are far reaching and support the economic, social and environmental recovery of a community following cyclones and storm tide.

This Guide is designed for use by home owners as well as the building, design and construction industry.

Further guides are available at www.qra.qld.gov.au/Resilient-Homes and include:

- *Cyclone Resilient Building Guidance for Queensland Homes*
- *Flood Resilient Building Guidance for Queensland Homes.*

Building the resilience of Queensland homes is another way we can work together to make Queensland the most disaster resilient state in Australia.

Get Ready Queensland

It is vital you understand your disaster risk so that you can stay safe during a cyclone or storm tide.

During a cyclone, you must evacuate your home if you live in a storm tide prone area and are directed to leave by emergency services.

For more information visit <https://getready.qld.gov.au/natural-disasters/cyclones>

Queenslanders are disaster resilient when...





Acknowledgements

This Guide was developed by the Cyclone Testing Station at James Cook University in conjunction with Systems Engineering Australia Pty Ltd (SEA).

Thank you to the following organisations for contributing to the development of this Guide:

- Queensland Government
- Bureau of Meteorology
- Master Builders Queensland
- Insurance Council of Australia
- Housing Institute of Australia
- Bushfire and Natural Hazards Cooperative Research Centre
- Local Government Association of Queensland
- Queensland Building and Construction Commission
- Australian Institute of Building Surveyors
- Suncorp Insurance
- Cassowary Coast Regional Council
- Douglas Shire Council
- Hopevale Aboriginal Shire Council
- Isaac Regional Council
- Livingstone Shire Council
- Mackay Regional Council
- Rockhampton Regional Council
- Townsville City Council
- Whitsunday Regional Council
- James Davidson Architect.

Contents

Understanding your risk

1. Introduction to storm tide resilient housing	6
2. Storm surges and storm tide	7
3. Understanding impacts from storm tide inundation	11
4. Understanding your risk	14

Storm tide resilient building strategies

5. Risk-based design	17
6. Resilient building design principles	21
7. Building new homes in a storm tide prone area	25
8. Resilient building materials	32
9. Improving the resilience of existing homes	38
10. Repairing or rebuilding after a storm tide	40

Appendices

11. Building approvals, codes and standards	42
12. Definitions	44
13. Resources	45

1. Introduction to storm tide resilient housing

This Guide provides information about designing and building storm tide resilient homes including:

- key issues associated with living in or building in storm tide prone areas
- design and building advice to minimise damage caused by storm tide inundation.

This Guide is non-mandatory and can be considered in line with the Building Assessment Provisions contained in the *Building Act 1975* and Queensland Development Code Mandatory Part MP 3.5.

This Guide does not replace the possible need to evacuate prior to a storm tide event. If you live in a storm tide prone area it is important to always be prepared in case you need to evacuate. Visit www.getready.qld.gov.au

If you live in, or are planning to build in a storm tide prone area, it is recommended you refer this Guide to contractors involved in the design, building or repair of your home to increase your resilience to storm tide.

1.1 Design standards for homes

This Guide provides design considerations for improving the storm tide resilience of homes to complement existing Australian standards for wind loads. Water is approximately 1000 times denser than air, which means that fast moving water generates larger forces on structures than wind.

State and council planning actively seeks to avoid development in low-lying coastal areas or imposes minimum floor levels on building approvals. However, there are no Australian housing design standards for resisting storm tide loads.

1.2 Building Assessment Provisions for Building Certifiers

The Building Assessment Provisions contained in Section 30 of the *Building Act 1975* dictate the laws and other documents under which building work must be assessed by a building certifier to allow a building development approval to be issued.

These include the *Building Act 1975*, *Building Regulation 2006*, Queensland Development Code (QDC) MP 3.5 and other relevant parts, and the National Construction Code (Building Code of Australia).

1.3 Queensland Development Code MP 3.5

The structural building measures contained in Queensland Development Code MP 3.5 specifically address the construction of buildings in flood prone areas and many of the principles may apply to houses in some storm tide prone areas.



2. Storm surges and storm tide

The Queensland coast is susceptible to storm surge generated by tropical cyclones. Depending on the tide levels, sea levels can rise considerably causing water to flood onto normally dry, low-lying coastal areas.

2.1 Storm surge

A storm surge is a persistent rise above the normally expected water level along a shoreline due to strong onshore winds and/or reduced atmospheric pressure typically caused by large-scale severe weather events. Storm surge is expressed as a magnitude (height) above the normal tide level. It takes several hours to fully rise and then fall.

The most damaging storm surges accompany tropical cyclones that come ashore or pass close to the shore. The rise in water level may be gradual at first. However, in severe events the water level can rise several metres per hour and be accompanied by destructive winds. The potential for a rapid rise in water levels accompanied by dangerous wind conditions means the only way to keep people safe is through early evacuation.

Storm surges of lesser magnitude may also form due to intense low-pressure systems in non-tropical areas and can also be caused by severe thunderstorms in some shallow water regions.

2.2 Storm tide

Storm tide is the term used to describe the combined effect of a storm surge and astronomical tide levels as shown below. The greatest impact occurs when the peak storm surge coincides with a high tide.

The diagram below compares normal conditions with those occurring during a cyclone. Normally the sea level varies between the local Highest Astronomical Tide (HAT) and the Lowest Astronomical Tide (LAT) levels. Breaking waves are in addition to HAT and LAT levels.

Illustration of a storm tide event (before and during)

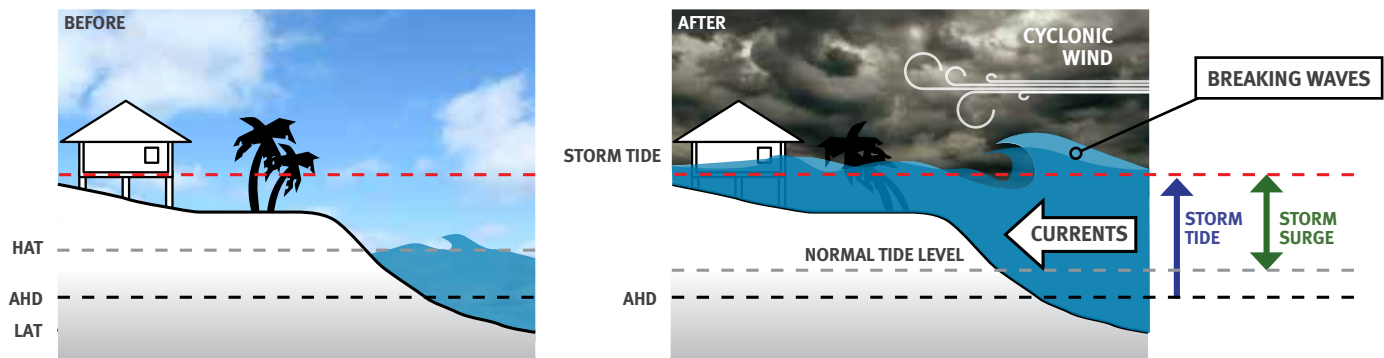

The height of the storm tide is measured above the Australian Height Datum (AHD), which is close to the Mean Sea Level or mid-tide height.

The combined effects of the storm tide and waves can damage or destroy buildings and wash roads away. Pounding waves on top of the storm tide are generated by powerful winds, which can increase water levels even further through a process called Breaking Wave Setup. The extent of sea water flooding from a storm tide can span up to 100 kilometres along the coastline and up to several kilometres inland in low-lying areas, lasting for several hours.

Storm tide damage following cyclones



Damage to houses at beachside communities caused by storm tide inundation during Cyclone Yasi in 2011 and Cyclone Debbie in 2017.

Some houses were battered by waters and pushed off their stumps, others remained in place despite extensive damage.

History of storm tide events in Queensland

Since to the 1900s, Queensland has recorded more than a dozen tropical cyclones resulting in storm tides reaching at least one metre above the HAT level.

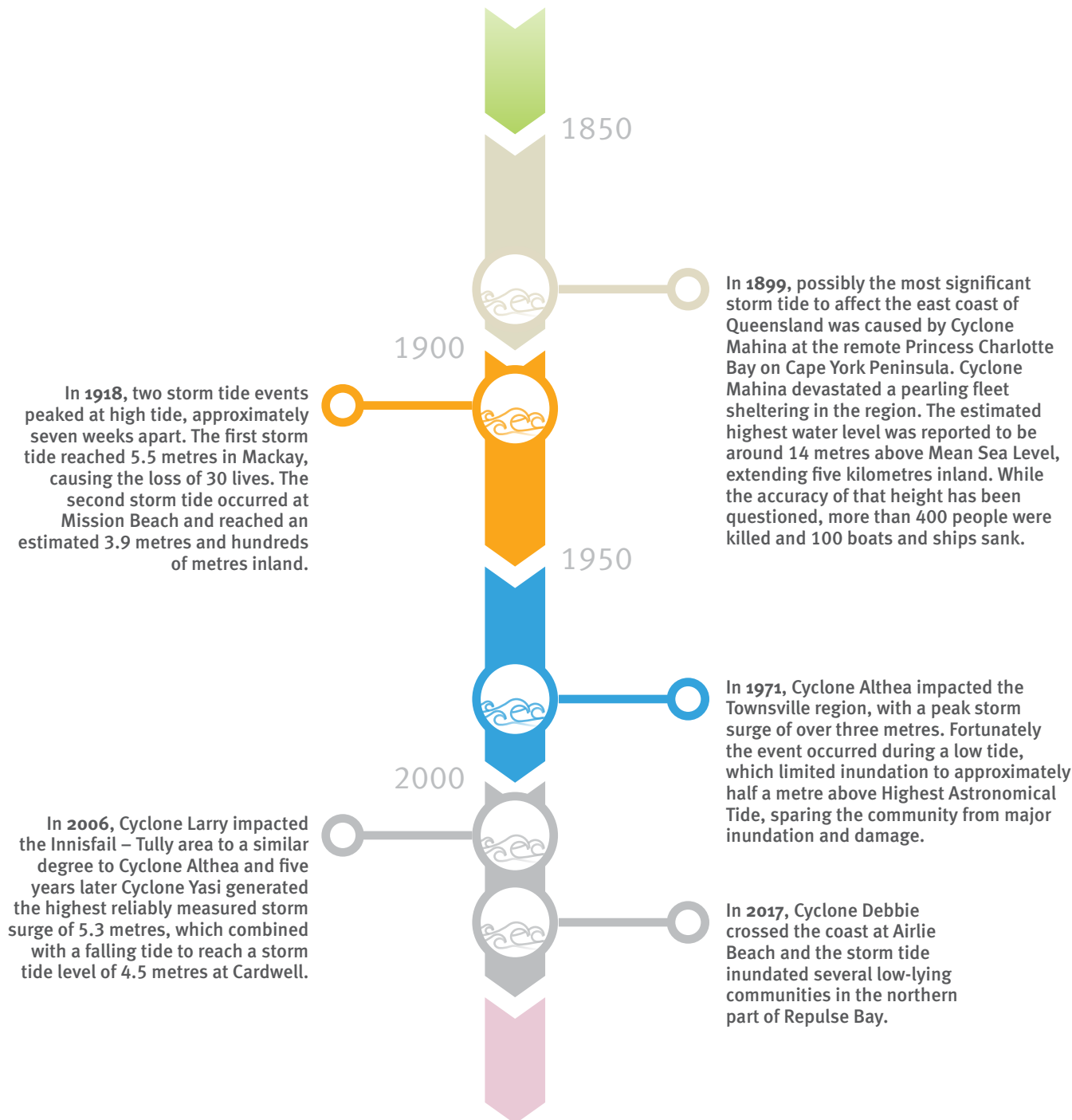

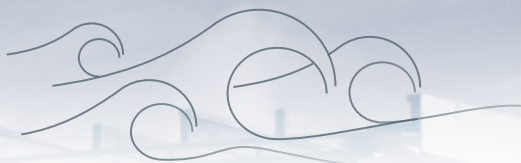

3. Understanding impacts from storm tide inundation

Storm tides can impact coastal homes in the following ways:

3.1 Water height above ground

Water inundation can extend into areas wherever the height of the storm tide exceeds the height of the land. Seawater will inundate homes when the ground floor height is lower than the height of the storm tide, often causing water damage to floor coverings, internal walls and fixtures, furniture and appliances.

In some sheltered coastal locations, seawater inundation can occur with small variations in wave or current activity. In other locations the impacts from waves and currents can be highly destructive, even before the water level rises above floor level.

3.2 Waves

Waves increase at the peak of the storm tide when the depth of water is at its highest, causing greater damage to homes. The height of a storm tide refers to a theoretical Stillwater Level without any waves. However, unless there is significant shelter against sea or wind, waves will always be present.

Wave forces can be significant. Most wall construction is usually unable to resist waves around one metre high. Even if the load on freestanding piers or stumps is not sufficient to cause structural failure, the crest of the wave may cause entry of seawater at the floor level well before the storm tide level reaches that height. The greatest wave force will be experienced when a wave breaks against a part of the home.

3.3 Debris

Debris from damaged buildings, fences and other structures can accumulate in the flood waters. Waves, wind and currents can forcefully drive debris into homes, causing further damage.

3.4 Flooding currents

As the storm tide begins to flood the land, currents can erode the typically-sandy soils of beach side homes. Erosion tends to occur in and around the supporting structures, walls and piers, which can undermine the integrity of the structure. In addition, when the water is deep enough the breaking waves produce strong currents that can rapidly scour out sandy soil in and around the base of homes.

3.5 Ebbing currents

As the storm tide recedes, currents returning to the sea can create further damage. Their effect depends on the extent of inundation, local topography and the rate at which the sea level returns to normal. In the absence of natural creeks and waterways to distribute the ebb currents, streets often become the waterway and can channel strong currents through and around homes located in low lying areas. These ebbing currents can cause severe erosion and structurally-dangerous scouring around house foundations.

3.6 Backwater effects

It is common for storm tides to penetrate through creek and mangrove pathways, flooding homes located further inland before affecting homes in elevated areas closer to the beach front. These backwater flooding effects are likely to occur during events with less wave activity. Homes located near the shoreline may have been built on ancient sand dunes that offer a small height advantage relative to more recent inland developments.

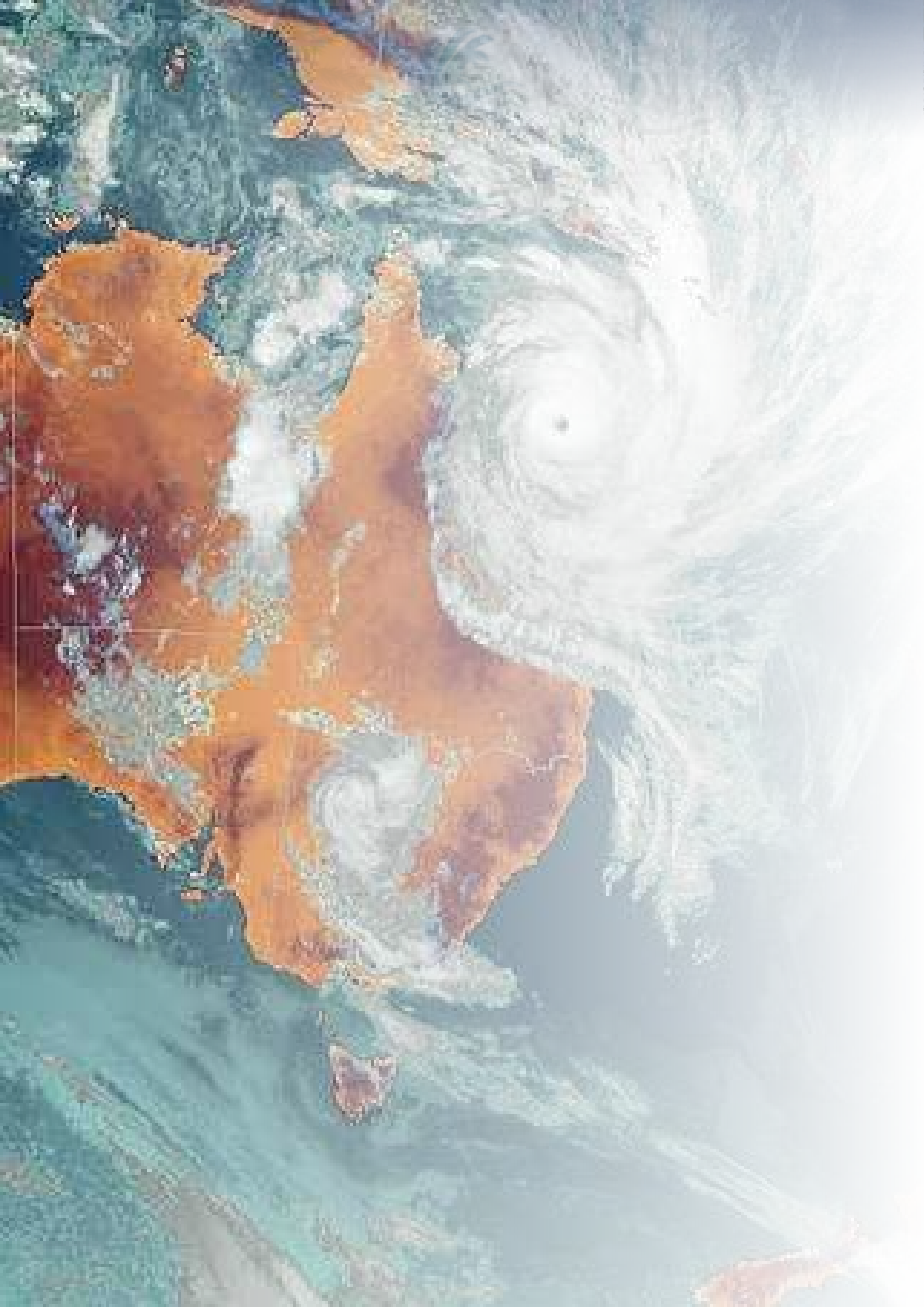

Case study – storm tide from Tropical Cyclone Yasi

Just after midnight on 3 February 2011, Severe Tropical Cyclone Yasi crossed the coast near Mission Beach, approximately 138 kilometres south of Cairns and 30 kilometres north of Cardwell. The storm surge during Cyclone Yasi raised the ocean level to more than five metres above the normal tide at Cardwell and up to three metres higher at the Clump Point tide gauge. The small coastal communities of Tully Heads and Hull Heads located between these two tide gauges were significantly affected.

The following graph shows the reconstructed record from the Cardwell storm tide gauge during Yasi, where the red line is the actual water level (storm tide) that was experienced (4.5 metres AHD) and the dashed black line is the predicted tide variation for that day. The difference between these is the green dashed line (storm surge), which reached 5.3 metres in magnitude and is the highest reliable storm surge ever recorded in Queensland. The black horizontal dashed line is the HAT level, which was exceeded by more than two metres.

Reconstructed Yasi storm tide event based on the Cardwell tide gauge

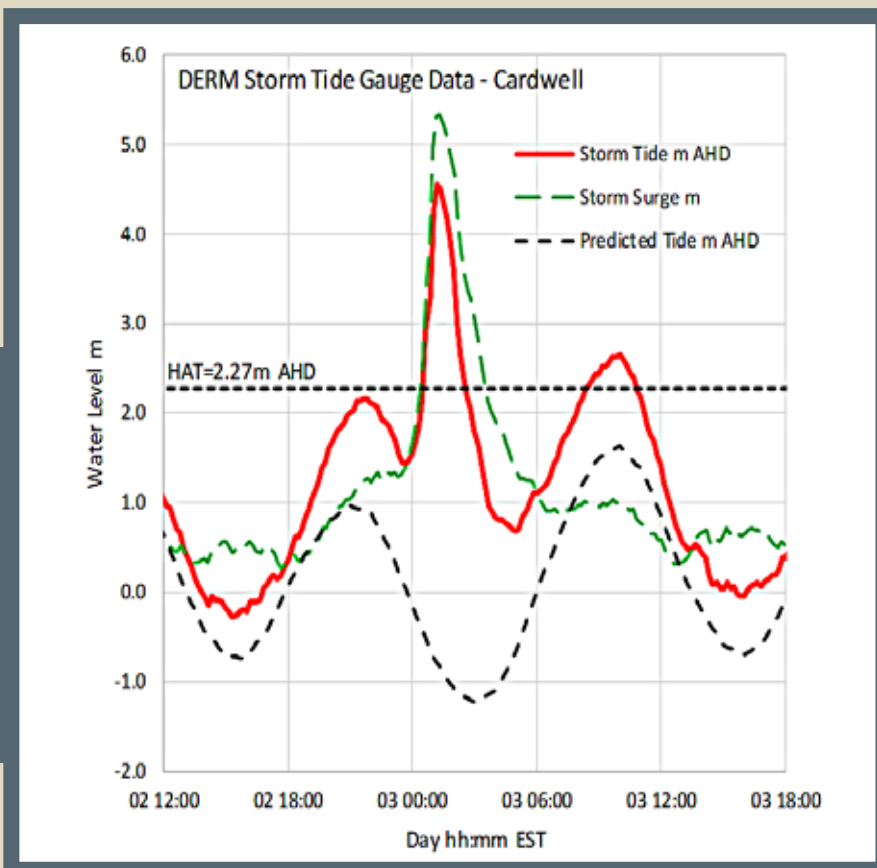

CASE STUDY

If Cyclone Yasi had crossed the coast nine hours later, at the time of the highest tide of the day, the storm tide could have risen another two metres.

In terms of risk, the area was subjected to a rare event, measuring up to a 0.1% (1 in 1000) Annual Exceedance Probability (AEP) risk level.



4. Understanding your risk

The preferred long-term defence against storm tide effects on new communities is avoidance of the risk through land use planning. However, where communities are already established in areas of storm tide risk, flood resilient design and construction can limit the long-term costs for home owners by reducing expected costs associated with flood damage and insurance premiums.

The National Construction Code adopts an implied level of risk and includes mandatory minimum standards for construction to resist events due to fire, wind and earthquakes, and address many other functional, health and safety considerations. There is no national standard or guideline that outlines building considerations for a storm tide.

4.1 Understanding your storm tide risk

The first step to making a home storm tide resilient is to understand the level of storm tide risk. It is also important to find out what council planning considerations or building regulations apply to your property.

Contact your council to understand your storm tide risk, including what impact a Defined Storm Tide Event (DSTE) would have on your home and to confirm any specified minimum planning considerations that apply to your residence such as building heights.

Once storm tide risk is understood, you can start to factor in the benefits of investing in storm tide resilient measures for your home.

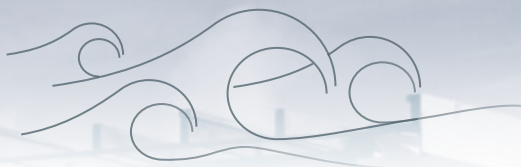

Cyclone storm tide hazard in Queensland

The risk of storm tides varies across Queensland depending on the intensity and frequency of tropical cyclones and differences in coastal features such as shallow nearshore waters and adjacent low-lying land.

Extensive studies have been undertaken into cyclone storm tide hazard across Queensland. To help residents appreciate storm tide Australian Height Datum (AHD) elevations in their local community, the Queensland Government produced the *Storm Tide Reference Landmarks Report*, which contains site-specific landmark photographs across Queensland showing their indicated Australian Height Datum elevation and HAT level.

Image of the HAT level at the Beach Club: Lizard Island Resort as detailed in the Storm Tide Reference Landmarks Report

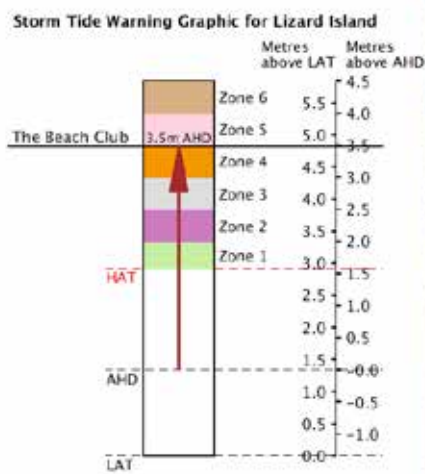

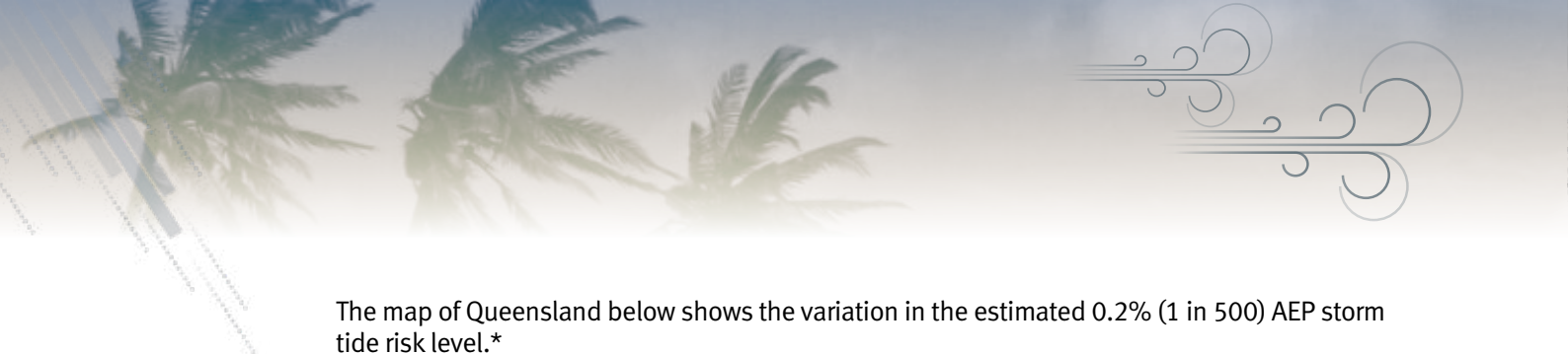

The map of Queensland below shows the variation in the estimated 0.2% (1 in 500) AEP storm tide risk level.*

The red markers in the Gulf of Carpentaria indicate where the storm tide level is estimated to be more than three metres above the HAT level. The red and orange markers indicate higher storm tide levels in areas such as Hervey Bay and the coast between Townsville and Cairns.

The blue markers indicate areas of low storm tide risk. In these areas the 0.2% (1 in 500) AEP storm tide level may not even be as high as the HAT level.

*The storm tide risk levels (including wave setup) are expressed as a height relative to the HAT to account for tidal plane variations.

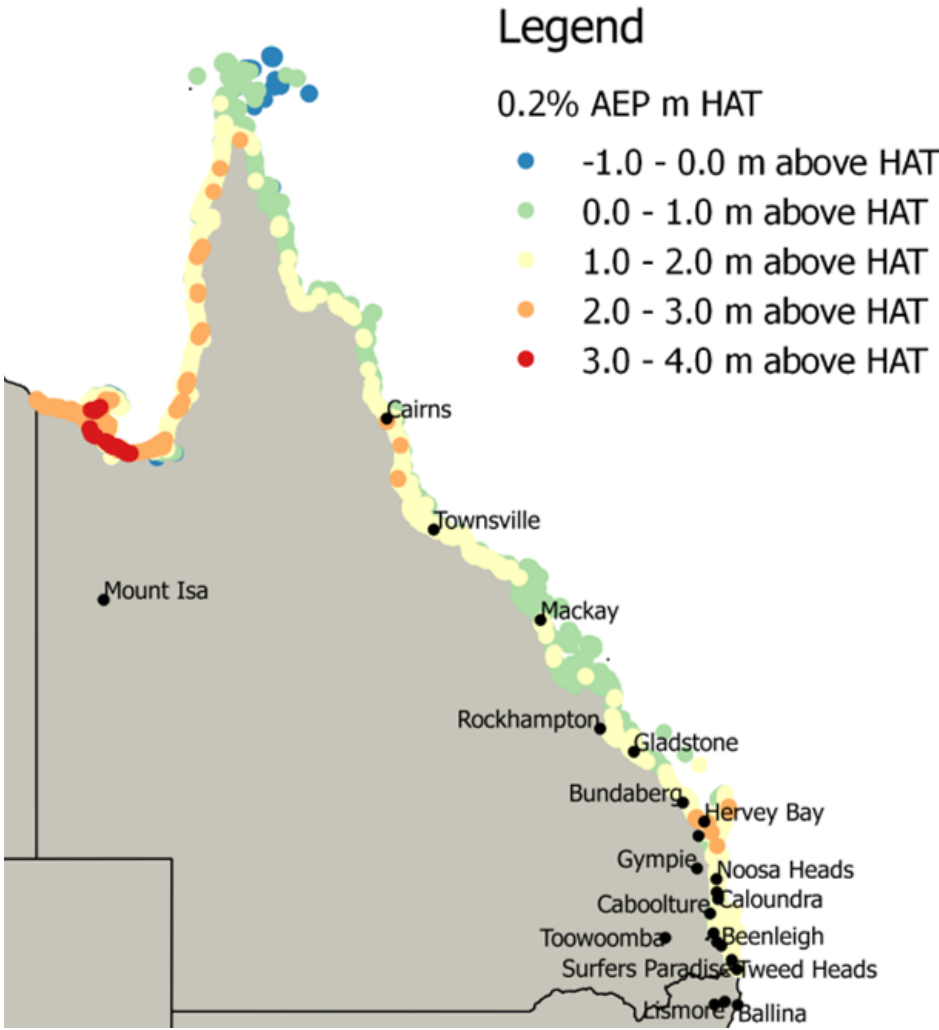

Image provided by Systems Engineering Australia.

5. Risk-based design

Building outside of storm tide prone areas is not always possible. If you choose to accept this risk, careful consideration of your house design and location can reduce the extent of damage to your home and properties around you during a storm tide.

The impacts of a storm tide depend on the elevation of your property, proximity of your home to the shoreline, shape of surrounding land and roads, and height of the waves. Most storm tide damage is experienced by properties directly exposed to incoming ocean waves, which is typically those within 100 to 200 metres of the open shoreline. The presence of foreshore erosion protection (revetments or seawalls) or vegetation is unlikely to provide significant protection from storm tide impacts. The first line of houses along the shoreline is likely to experience the greatest impact.

5.1 Seeking professional advice

Councils adopt a minimum planning water level for storm tide inundation in accordance with the guidelines outlined in the *Coastal Management Plan*. The plan currently considers water heights, but does not allow extra height for waves. Contact your council to determine the minimum floor height you need to adopt. Depending on your level of risk, you may consider designing your home to a higher storm tide level than the minimum prescribed level.

A professional coastal engineer can confirm whether your property is likely to be affected during a storm tide and the associated level of risk you may be accepting.

Finding a licensed professional

Ensure only licensed professionals are involved in the repair or rebuild of your home by checking their credentials. Visit the following websites to find a licensed professional in your area:

Licensed builders, tradespersons, and building certifiers and designers

Queensland Building and Construction Commission

www.qbcc.qld.gov.au

Licensed coastal and structural engineers

Board of Professional Engineers Queensland

www.bpeq.qld.gov.au

Licensed architects

Queensland Board of Architects

www.boaq.qld.gov.au

5.2 Site planning – location and orientation of building structures and landscaping

The initial destructive forces from a storm tide come from the open waterfront and in most cases travel at right-angles to the shoreline. The impact of associated waves may be affected by the height of foreshore dunes and surge resistant vegetation, although these defences may be washed away in severe inundation events.

Careful consideration should be taken when locating structures on your property. Above ground structures are at risk of being dragged away and in turn causing further damage to surrounding homes. Fences can catch debris, be dragged from the ground and then swept against houses. Plastic or metal water tanks may similarly be moved by waves or the ebbing water as it returns to the sea.

These structures should incorporate resilient building principles to minimise their exposure to wave forces. For example, reinforcing concrete tanks with footings or supports that are able to resist wave forces.

Mature and healthy coastal tree species may reinforce soft dunes against storm erosion. It is important to maintain the healthy condition of trees so they don't become damaged from heavy winds and waters, and become dangerous debris.

Fences, sheds and light-weight water tanks may be swept away and may become a risk to you and your neighbour's home.

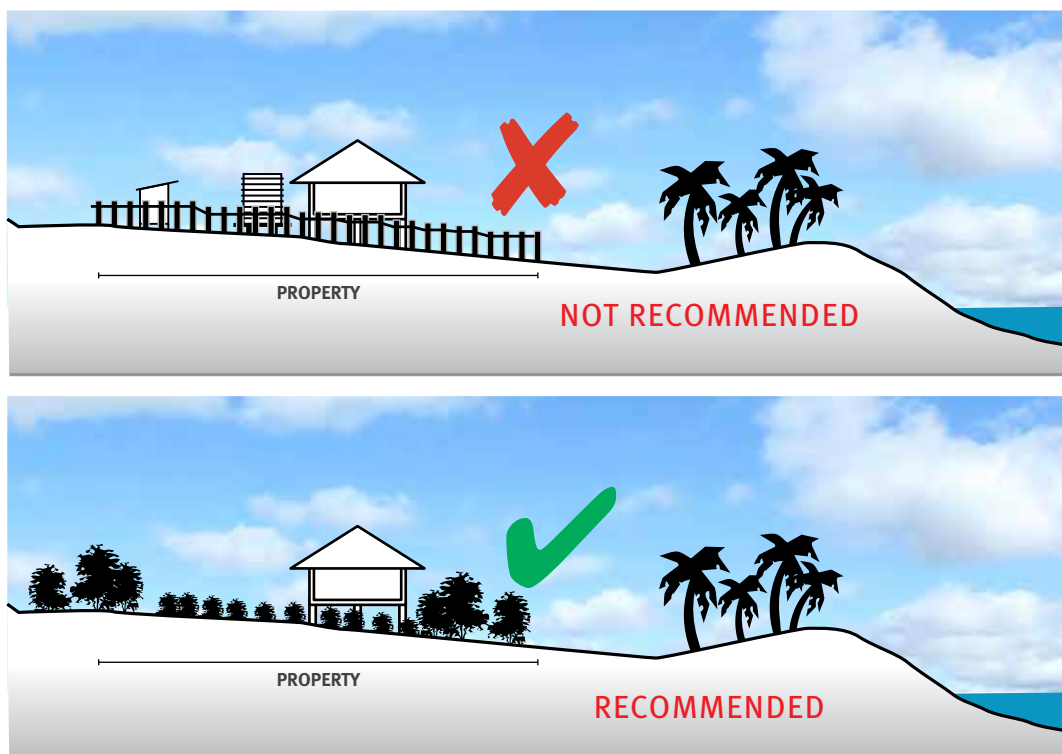

The following images show damage to homes relative to the level of water through the property.

Greater than 1m and significant damage to unreinforced masonry



If more than 1m, significant damage to interior of house, fixtures and fittings



Approximately 600mm and minimal structural damage to reinforced concrete block construction, but still significant damage to the interior fixtures and fittings



Minimal structural damage if floor heights are above level of water inundation



Storm tide level (approx)



If less than 200mm, only minimal structural damage but possible water damage to flooring and plasterwalls

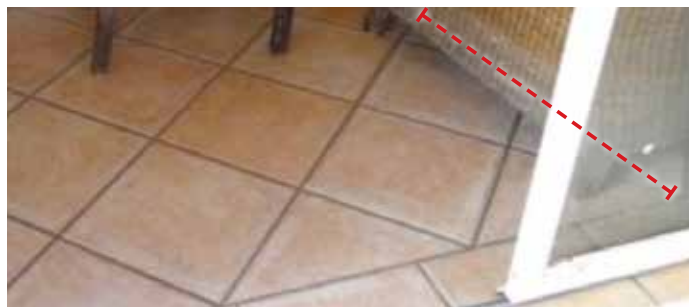

Photos courtesy of the Cyclone Testing Station

5.3 Building resilience to storm tide

The National Construction Code requires that a building or structure must perform adequately under all reasonably expected design loads and actions and withstand extreme or frequently repeated design events. In a storm tide prone area this can be inferred to include scour, seawater currents and wave forces.

Single storey homes must withstand considerable seawater current and wave forces, which usually requires a reinforced concrete construction. The lower storey of double storey homes must be strong enough to support the upper level under extreme forces.

Building options that allow seawater to flow through buildings are provided in the following sections.

6. Resilient building design principles

All new homes in cyclone-prone areas must be designed in accordance with Australian Standards to withstand wind loads to at least the 0.2% (1 in 500) AEP wind event.

In addition, new homes in storm tide areas should be designed to minimise the potential damage caused by storm tide and breaking waves.

Cyclone-generated waves can be extremely powerful and are capable of moving heavy objects such as cars, caravans, boats on trailers, trees, fences and sheds, causing damage to anything in their path.

Protect your home and possessions from storm tide by locating habitable spaces as high as possible above the estimated maximum storm tide level identified for your location.

Building design to avoid waves and water

The habitable floor level of homes in storm tide areas should be set as high as possible and adopted storm tide level above the maximum estimated storm tide level for that location. In building design terms, the level of hazard exposure for storm tide is categorised as Exposure I or W. Assume your home has Exposure W unless advised by an experienced coastal engineer.

- **Exposure I (Inundation)** – homes located further from the beach front or close to tidal creeks that are likely to be inundated by storm tide.
- **Exposure W (Waves)** – homes located closer to the beach front that are likely to be both inundated by storm tide and affected by waves.

6.1 Storm tide loads on houses

In addition to the wind loads, homes inundated by storm tide can experience:

- drag forces due to moving water
- impact forces from waves and debris
- buoyancy forces if the water rises above floor level.

6.2 Breakaway Walls

Breakaway Walls are expendable walls that are designed to fail when impacted by fast flowing water during a storm surge. The connection point between the Breakaway Walls must be the weak point so that they break away cleanly on all sides without damaging the rest of the home. They are suitable to enclose garages, storage or work areas under high-set houses, or as non-load bearing walls in the lower level of two storey homes.

Some examples of Breakaway Walls include lattice, flyscreen or light-weight framed walls with weak connections to the stumps. Breakaway Walls should not have any wiring or plumbing attached to them that could anchor the walls to the house or ground and prevent them from breaking away cleanly.

Examples of Breakaway Walls

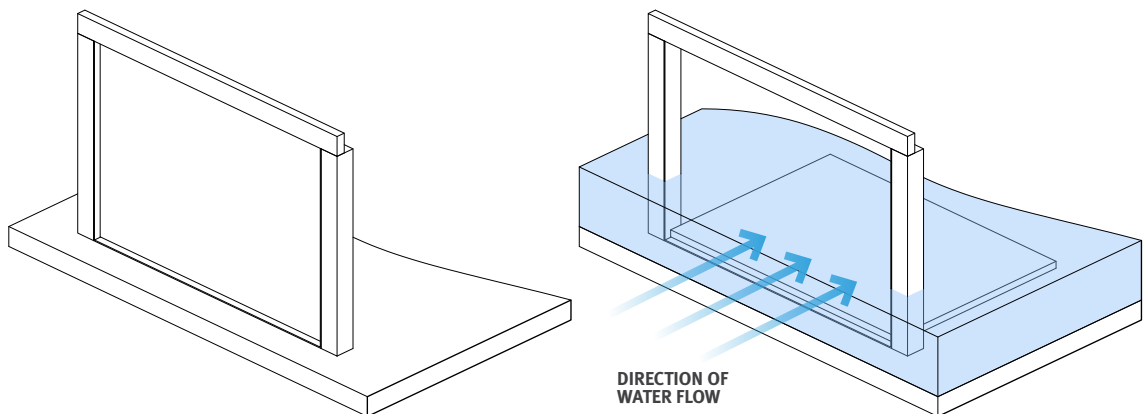

6.3 Corrosion resistant metal fittings

Coastal environments can accelerate corrosion in metal fasteners and fittings. It is important that appropriate connectors and fittings are installed in your home to ensure they remain serviceable before, during and after a storm tide event. If connections have corroded, pieces of the home may break away during a storm tide or wind event.

Metal elements can be protected from corrosion by heavy galvanising on thicker pieces of steel or the use of 316 Grade stainless steel connectors.

Consult an engineer with experience in corrosion protection for advice on the most suitable metal connections and fittings for your home.

Some metal elements can corrode when in contact with one other, which is why it is important to ensure that metals are compatible. For example, stainless steel frame anchors should only be fixed to timber using stainless steel screws or nails, or plastic-coated screws.

Compatibility of metals

Contacting metal				
Metal	Aluminium	Copper	Stainless steel (300 series)	Zinc-coated steel
Aluminium*	Yes	No	No	Yes
Copper*	No	Yes	No	No
Stainless steel (300)	No	No	Yes	No
Zinc-coated steel	Yes	No	Yes	Yes

*including alloys

6.4 Concrete in storm tide areas

In storm tide areas, concrete in and around homes needs to be resilient to immersion in sea water. Sea water resistant concrete has the following attributes:

- low water-cement ratios – generally used in N32 concretes
- additional concrete cover over the reinforcement
- galvanised reinforcement.

If steel reinforcement starts to corrode, the concrete could split and crumble, significantly decreasing the concrete's strength.

6.5 Protection of slabs, footings and foundations

Footings and stumps such as piles, piers and columns need to be protected from the effects of scour and erosion by storm tide currents and waves. The depth of erosion and scour will vary depending on the soil type and foundations as follows:

- depth of scour around stumps could reach twice the diameter of the stumps
- depth of scour beside walls or concrete slabs could be 0.15 times the length of the wall or slab.

Scour protection can be achieved by:

- increasing the embedment depth of stumps and piles. Note: increasing the diameter of stumps will not provide protection from scour or erosion
- burying strip footings under walls
- providing protection around the edges of concrete slabs with a wall below the level of the slab that is at least 600 mm deep.

Properly designed and constructed footings can withstand limited scour and erosion impacts during a storm tide.

Protection of concrete slab edges against scour

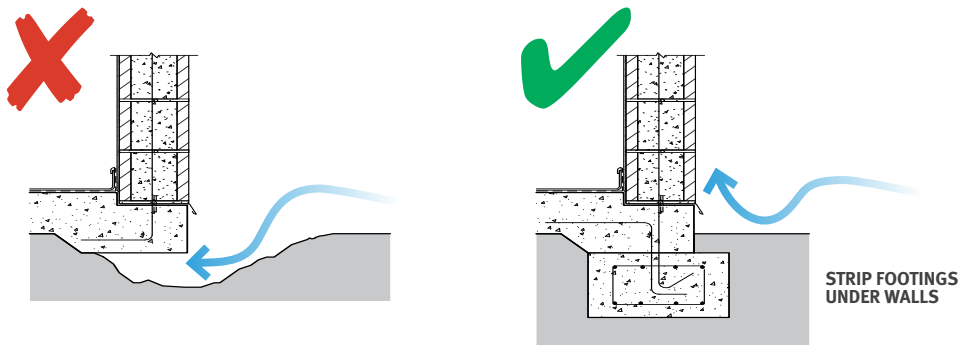

7. Building new homes in a storm tide prone area

A well designed home can withstand the impacts of storm tide with minimal damage and is easier to clean afterwards. Building within a potential storm tide inundation area may also have implications for your home and contents insurance. The following recommended strategies and resilient building materials should be considered when building a new home in a storm tide prone area.

- 1. The best strategy is to build the habitable floor level as high as possible from the ground.**
In addition, the building elements below the habitable floor level should provide as little resistance as possible to the flow of seawater.
- 2. Use appropriate materials and ensure they are properly maintained.**

Home floor level above storm tide

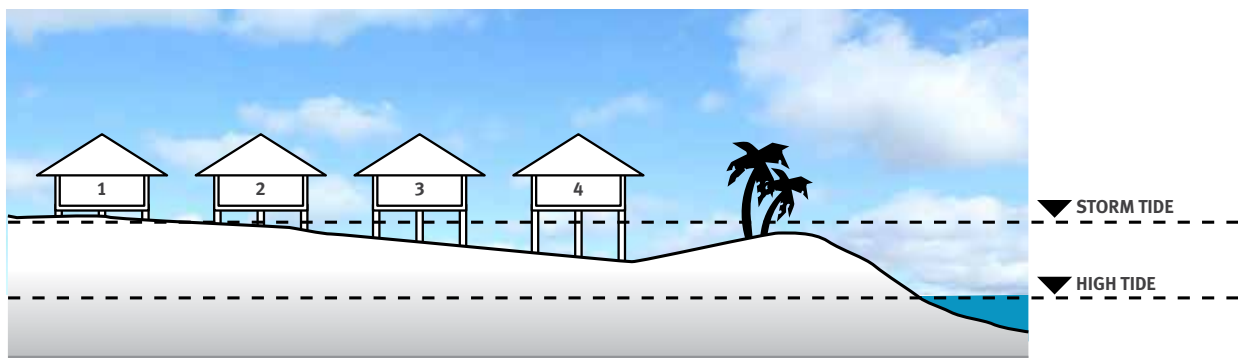

The following design principles will help minimise damage from storm tide and reduce clean-up and repair costs:

- Understand the potential height range of storm tides in your location.
- Understand the exposure category (I or W) of your home (Refer **Section 6**). Assume your home has Exposure W unless advised otherwise by an experienced coastal engineer.
- Select a suitable design such as:
 - high-set home on stumps
 - low-set home on stumps
 - two-storey home.
- Select suitable building materials (Refer **Section 8**).
- Select a suitable layout for parts of the home located below the adopted storm tide level such as:
 - for Exposure W homes, minimise the number of solid walls for any part of the home below the adopted storm tide level
 - where possible, align solid or load-bearing walls below the potential water level perpendicular to the coastline so they offer the least possible resistance to storm tide and waves
 - design walls in parallel to the coastline as non-load-bearing breakaway walls.

7.1 Issues to raise with your builder or coastal engineer

Discuss the following checklist with a qualified professional:

- wind classification for your home
- storm tide height
- storm tide exposure classification (I or W)
- home type – high-set, low-set, two storey etc
- habitable floor level height
- location of services such as electricity and plumbing
- building materials suitable for above and below the adopted storm tide level
- foundation systems suitable for withstanding scour and erosion by storm tide
- strength of building to resist loads from both wind and storm tide.

7.2 High-set home on stumps

High-set homes on stumps are generally considered the most effective design to minimise storm tide damage in high-risk areas. The habitable floor level should be higher than the maximum estimated storm tide level, including an allowance for waves if classified as an Exposure W home. This design allows water to flow through the space under the house. It is therefore recommended the lower level of the home be used for parking or temporary storage.

General principles for consideration to enable waters to flow through or under the home:

- Use materials recommended in **Section 8**
- Construct Exposure W homes using resilient materials that can resist wave action and withstand inundation
- Construct Exposure I homes using building materials that can withstand inundation
- Do not permanently enclose the lower storey. Areas underneath the habitable floor level should be designed to enable water to flow through without being trapped or impeded.
 - Design considerations include:
 - install conventional garage doors that close for day-to-day use and can be opened before a potential storm tide event
 - plan to remove all items stored under the main habitable floor before a potential storm tide event to protect those items and prevent them from damaging the stumps or sub-floor bracing
 - design small laundries and workshops located under the main habitable floor level to be as compact as possible so they provide minimal resistance to moving water
 - install stairs that are not closed in underneath, and with open risers so that water can move freely under and through them
 - use ramps that are open underneath
 - ensure stumps including those that support stairs and ramps are embedded at least one metre into the ground.

- Walls installed in the lower storey of Exposure W homes, and aligned parallel to the coastline, should be breakaway walls.
- Subfloor supports should have:
 - scour protection for stumps and footings
 - capacity to withstand storm tide forces and impact from debris in moving water while still supporting the weight of the house
 - steel cross-bracing that is at right angles to the shoreline.
- Provide edge protection to any ground level slabs to prevent damage from scouring and erosion.

Design the ground level of high-set homes to support the floors above, while allowing water to flow through the lower level.

Design for clear flow of water under a high-set home

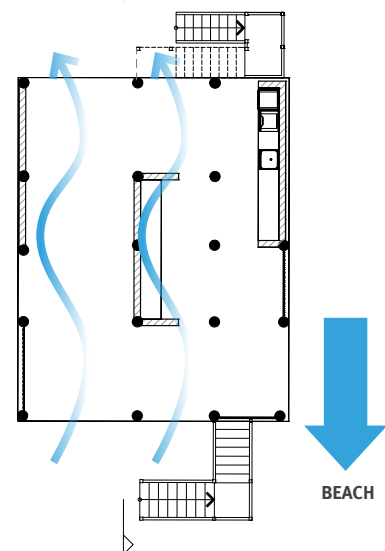
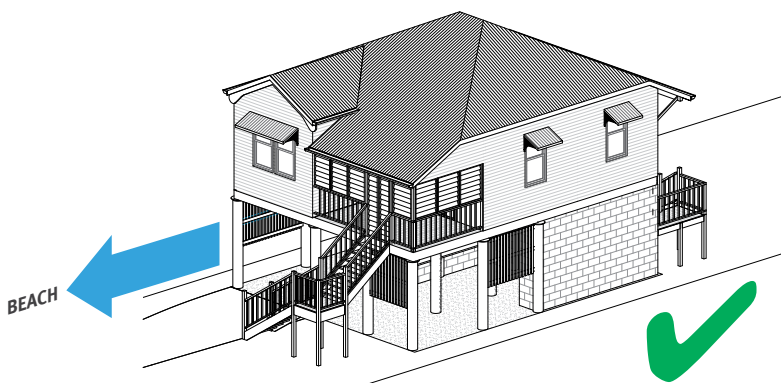
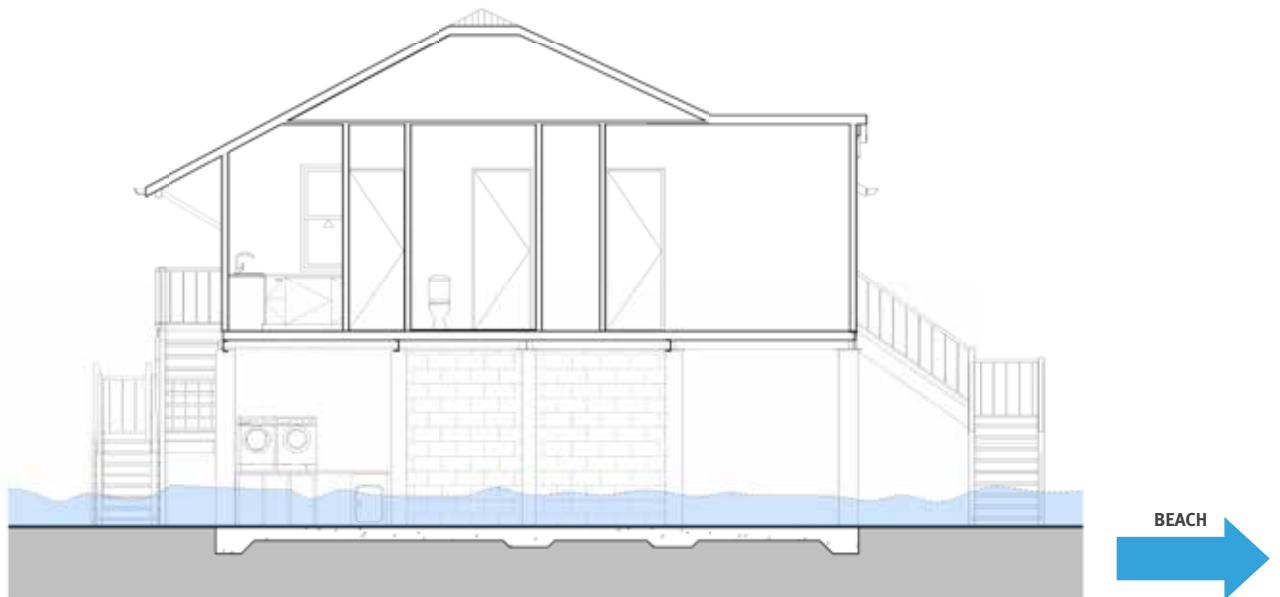

7.3 Low-set home on stumps

A low-set home on stumps is an option for Exposure I homes with low inundation levels that will enable ramp access for people with mobility issues.

It is still recommended that the habitable floor level be raised as high as practicable above the maximum estimated storm tide level. Other design strategies include:

- Use materials recommended in **Section 8**.
- Construct Exposure W homes using building materials that can resist waves and water inundation.
- Construct Exposure I homes using building materials that can withstand water inundation
- Use open foundations systems such as stumps or piles.
- Do not enclose the subfloor area with brick or concrete walls.
- Avoid any lightweight cladding unless it is a breakaway wall.
- Where possible, position stairs and ramps with the smallest dimension facing perpendicular to the shoreline and build ramps using open piles.
- Subfloor supports should have:
 - scour protection for footings
 - capacity to support the home and withstand storm tide forces and impact from debris in the moving water
 - steel cross bracing at right angles to the shoreline.

Exposure W homes should incorporate strong impact resistant stumps and deep foundations. External wall cladding should be able to withstand the impacts from waves. Sufficient bracing is also required below the habitable floor level to resist wind loads and waves that may hit the side of the house during a storm tide.

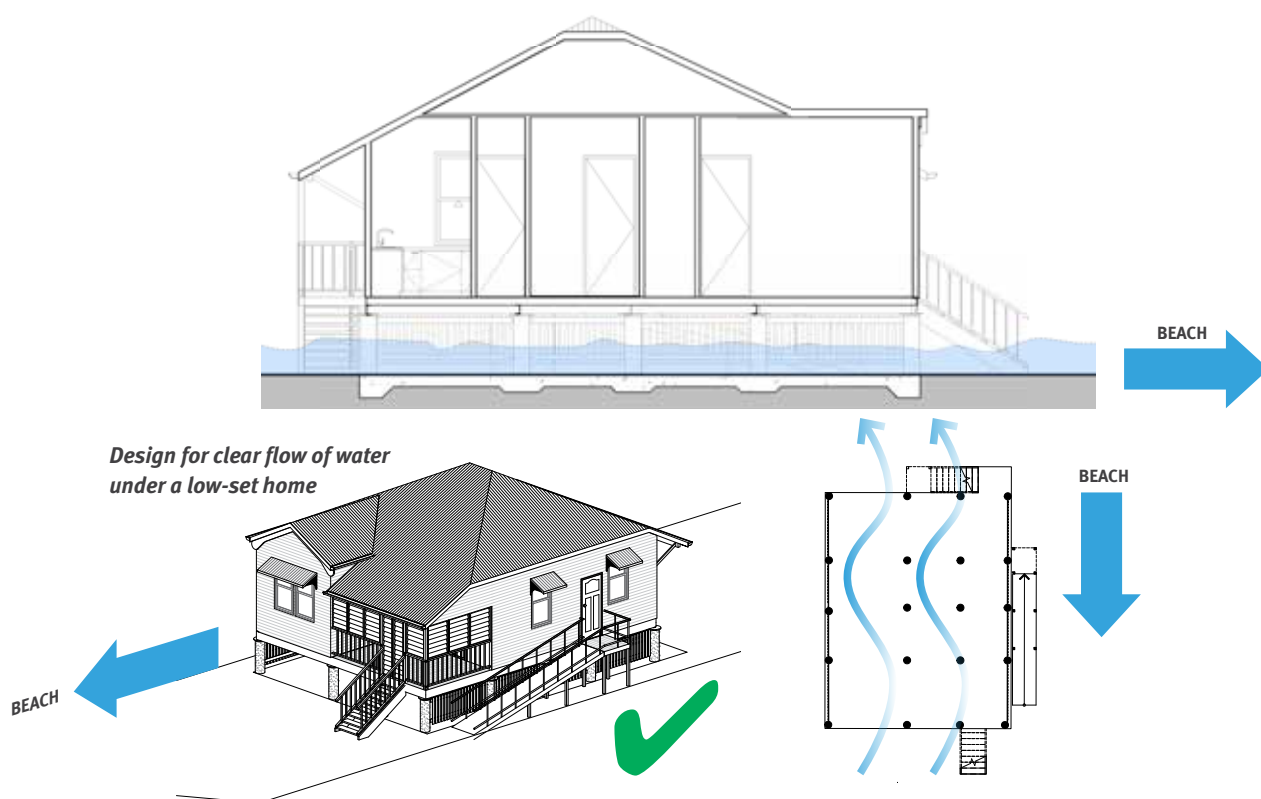

7.4 Two-storey homes

Two-storey homes built on a concrete slab on ground will experience seawater flowing through the lower level during a storm tide. Two-storey homes can also be built on an elevated platform above the adopted storm tide level (Refer to high-set homes on stumps).

Two-storey flow through design for Exposure W homes



7.4.1 Upper storey

Use the recommendations provided for high-set homes.

Where the upper storey is above the estimated maximum storm tide level, possessions can be moved from the lower storey to the upper storey before a storm tide approaches to protect them from water damage. To facilitate this, it is important to design the stairs so that furniture and larger items can be easily and quickly moved to the upper storey.

7.4.2 Lower storey slab on ground

Provide protection from scour and erosion around the edges of the concrete slab as referred to in **Section 6** of this Guide. Choose resilient floor coverings and wall linings.

Exposure W homes – assume seawater will flow through the lower storey with wave impacts. Design recommendations include:

- use the building materials recommended in **Section 8**
- incorporate large windows or doors in the walls facing towards and away from the shoreline, and use an open plan design to allow seawater and debris to flow through the lower storey with as little resistance as possible
- alternatively, design as many walls as possible that are parallel to the shoreline as breakaway walls.

Exposure I homes – assume water inundation will occur on the lower level, but will mostly be protected from the effects of the storm surge currents and breaking waves.

Where maximum storm tide inundation is estimated to be less than one metre above the habitable floor level, the lower storey can be designed to force the water to flow around the building. To do this, design strong walls with small windows that are well protected by heavy storm shutters to withstand the impact of wind-borne debris. The shutters may also resist water currents, but will still allow water to flow through the lower level of the home.

Where storm tide inundation is estimated to be more than one metre above the habitable floor level, currents in the deeper water may have sufficient strength to break heavy shutters on full length windows. In this case, sea water will flow through the lower storey and consequently the lower storey should be designed the same as for Exposure W Homes.

7.5 Single storey slab on ground homes

Single storey slab on ground construction should not be used for Exposure W homes. During a storm surge, water and waves can flow through the entire home causing significant damage to home and contents.

This type of construction is also not recommended for Exposure I homes, as inundation from seawater is likely, causing significant damage to home and contents.

If a single storey slab on ground home is the only option:

- refer to the design guidelines in the section on lower storey slab on ground
- avoid mounting mechanical or electrical equipment such as air conditioners below the estimated maximum storm tide level
- design decks using the same sub-floor system as the house – concrete decks require reinforcement that is corrosion resistant
- decking boards should have gaps between them to allow water to flow through, and for air to circulate around them to dry them out after the water has subsided.

Single storey flow through design for Exposure W homes

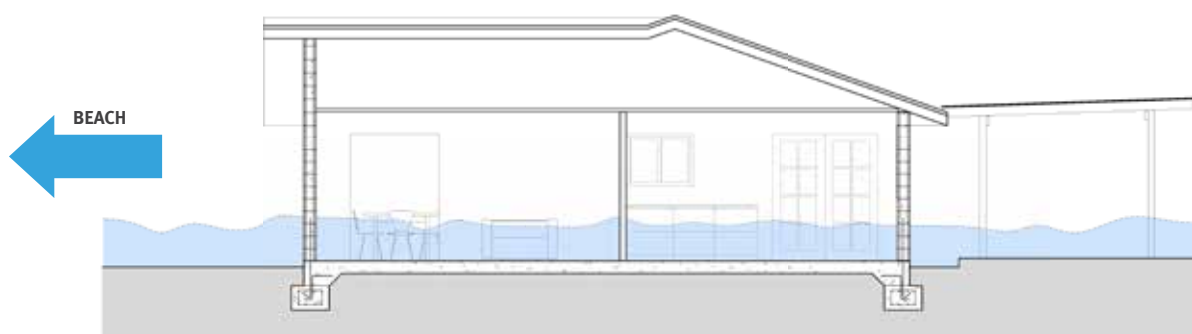

8. Resilient building materials

8.1 Materials for homes above the adopted storm tide level

Exposure W and I homes – external and internal materials should withstand wind actions expected in tropical cyclones and soaking from sea water and rain. Plasterboard or particle board are not recommended for use in structural elements such as floors and load bearing walls. Water resistant plasterboard or particle board is however recommended for non-structural fixtures such as kitchen cupboards or built-in wardrobes.

Exposure W homes – external building materials must be designed to withstand waves that are high enough to affect the upper parts of the home.

It is important to note, it is not safe to shelter in your home during a storm tide event, even if your house is designed using the strategies outlined in this Guide. You should evacuate when advised, leaving plenty of time to avoid rising water on access roads.

8.2 Materials for homes below the adopted storm tide level

Exposure W homes – materials should withstand impacts from waves and debris, hold their strength when wet, dry easily and be resistant to deterioration after inundation by seawater.

Exposure I homes – materials should be resistant to moisture damage, maintain their strength when wet and dry easily after inundation.

Recommended materials for homes below the adopted storm tide level

	Exposure W	Exposure I
Subfloor structure	Concrete timber or steel stumps with a deep embedment to protect from scour	
Floor	Concrete	
Load bearing walls	Reinforced and fully core-filled concrete masonry or standard concrete panels	Reinforced and fully core-filled concrete masonry, standard concrete panels or light-weight concrete panels*
Non-load bearing walls	Breakaway walls	No special requirements
Internal wall and ceiling linings	Timber or fibre-cement panelling	
Wall insulation	Closed cell insulation	
Doors	Solid timber with waterproof adhesive in galvanised steel frames and corrosion resistant heavy-duty hinges and latches	Solid timber with waterproof adhesive, flush marine plywood with closed cell foam aluminium or galvanised steel frame (rather than hollow core or particle board)
Windows	Tempered (toughened) or laminated glass that can break away cleanly under wave action. Shutters should not be used on windows below the storm tide level to allow unimpeded seawater flow	Aluminium frames with corrosion-resistant fittings.
Floor coverings	Tiles, polished concrete	Tiles, polished concrete or some vinyl flooring systems
Structural fasteners (including nails)	Heavily galvanised or stainless steel	
Reinforcing for concrete and masonry	Heavily galvanised to minimise corrosion	
Structural timber	Treated to at least Hazard Class 3 (H3) level to resist moderate decay, borers and termites, and suitable for outside above-ground use	

** If cavity construction is used, install resilient cladding on the outside and extra deep skirting boards on the inside so they can be removed after storm tide inundation for access to remove mud and debris from inside the wall cavity and assist in drying.*

8.2.2 Further information about the performance of building materials located below the adopted storm tide level

Suitable

Materials or products are relatively unaffected by submersion in seawater and may remain in place after some wave actions. They are the best available for the particular application.

Mild effects

Materials or products are only mildly affected by seawater inundation and wave action, and are the next best choice if the most suitable materials or products are too expensive or unavailable.

Moderate effects

Materials or products are more likely to be damaged by seawater and/or wave action than the above category.

Severe effects

Materials or products are seriously affected by seawater and waves, and will need to be replaced if inundated.

Performance of building materials in Exposure W homes

Component	Suitable	Mild effects	Moderate effects	Severe effects
Floor, sub-floor structure	<ul style="list-style-type: none"> slab on ground suspended concrete 		<ul style="list-style-type: none"> standard grade plywood timber tongue and groove (ends only epoxy sealed and gaps between boards to allow for swelling) 	<ul style="list-style-type: none"> particle board flooring close to the ground
Wall structure	<ul style="list-style-type: none"> reinforced concrete 	<ul style="list-style-type: none"> reinforced block masonry 	<ul style="list-style-type: none"> full brick or block masonry (unreinforced) 	<ul style="list-style-type: none"> brick or block veneer with venting (stud frame) cavity brick
Wall and ceiling linings	<ul style="list-style-type: none"> face brick or block work cement render ceramic wall tiles stone, solid or veneer 	<ul style="list-style-type: none"> standard bricks solid timber (fully sealed) exterior grade plywood (fully sealed) fibre cement sheet thicker than 10 mm 	<ul style="list-style-type: none"> exterior grade particleboard hardboard solid timber with allowance for swelling exterior grade plywood galvanised steel sheet, plastic sheeting or tiles with waterproof adhesive, glass blocks 	<ul style="list-style-type: none"> particleboard, fibreboard or strawboard wallpaper cloth wall coverings standard plywood gypsum plaster and plasterboard fibre cement sheet thinner than 10 mm

Component	Suitable	Mild effects	Moderate effects	Severe effects
Doors	<ul style="list-style-type: none"> no doors can be regarded as suitable to resist wave action 		<ul style="list-style-type: none"> flush or single panel marine ply with waterproof adhesive painted metal timber frame fully epoxy sealed before assembly solid panel with waterproof adhesive flush marine plywood with closed cell foam aluminium or galvanised steel frame standard timber frame painted metal frame 	<ul style="list-style-type: none"> standard flush hollow core with PVA adhesives and honeycomb paper core <p>Note: lowest cost to replace</p>
Window frames	<ul style="list-style-type: none"> aluminium frame 		<ul style="list-style-type: none"> timber frame (fully epoxy sealed before assembly, with stainless steel or brass fittings) UPVC frames 	<ul style="list-style-type: none"> timber with PVA glues mild steel fittings
Insulation			<ul style="list-style-type: none"> plastic or polystyrene boards closed cell solid insulation 	<ul style="list-style-type: none"> open-celled insulation – materials which store water and take a long time to dry out e.g. batts reflective foil perforated with holes to drain water if used under timber floors
Bolts, hinges, fittings	<ul style="list-style-type: none"> brass, nylon and stainless steel, removable pin hinges 	<ul style="list-style-type: none"> galvanised steel aluminium 		<ul style="list-style-type: none"> mild steel
Connections – nails and screws, etc.	<ul style="list-style-type: none"> stainless steel 	<ul style="list-style-type: none"> galvanised steel 		<ul style="list-style-type: none"> mild steel

Component	Suitable	Mild effects	Moderate effects	Severe effects
Floor coverings	<ul style="list-style-type: none"> clay and concrete tiles epoxy or cement floor toppings on concrete 	<ul style="list-style-type: none"> terrazzo ceramic tiles 	<ul style="list-style-type: none"> rubber or vinyl sheets or rubber tiles (with chemically set adhesives) polished timber floor floor rugs and mats 	<ul style="list-style-type: none"> loose fitting nylon or acrylic carpet (with closed cell rubber underlay) wall-to-wall carpet or seagrass matting cork linoleum timber overlay floors
Floor, sub-floor structure	<ul style="list-style-type: none"> slab on ground suspended concrete 	<ul style="list-style-type: none"> timber tongue and groove (ends only epoxy sealed and gaps between boards to allow for swelling) plywood 	<ul style="list-style-type: none"> standard grade plywood 	<ul style="list-style-type: none"> particle board flooring close to the ground

Performance of building material in houses with Exposure I

Wall structure	<ul style="list-style-type: none"> reinforced concrete 	<ul style="list-style-type: none"> full brick or block masonry 	<ul style="list-style-type: none"> brick or block veneer with venting (stud frame) cavity brick 	
Wall and ceiling linings	<ul style="list-style-type: none"> fibre cement sheet thicker than 10 mm face brick or block work cement render ceramic wall tiles stone, solid or veneer 	<ul style="list-style-type: none"> standard bricks solid timber (fully sealed) exterior grade plywood (fully sealed) fibre cement sheet thinner than 10 mm 	<ul style="list-style-type: none"> exterior grade hardboard solid timber with allowance for swelling exterior grade plywood galvanised steel sheet glass blocks plastic sheeting or tiles with waterproof adhesive 	<ul style="list-style-type: none"> particleboard, fibreboard or strawboard wallpaper cloth wall coverings standard plywood gypsum plaster and plasterboard
Doors	<ul style="list-style-type: none"> solid panel with waterproof adhesive flush marine plywood with closed cell foam aluminium or galvanised steel frame 	<ul style="list-style-type: none"> flush or single panel marine ply with waterproof adhesive timber frame fully epoxy sealed before assembly 	<ul style="list-style-type: none"> standard timber frame painted metal frame 	<ul style="list-style-type: none"> standard flush hollow core with PVA adhesives and honeycomb paper core. Note: lowest cost to replace.

Component	Suitable	Mild effects	Moderate effects	Severe effects
Window frames	<ul style="list-style-type: none"> aluminium frame with stainless steel or brass rollers UPVC frames 	<ul style="list-style-type: none"> timber frame (fully epoxy sealed before assembly, with stainless steel or brass fittings) 		<ul style="list-style-type: none"> timber with PVA glues mild steel fittings
Insulation	<ul style="list-style-type: none"> plastic or polystyrene boards closed cell solid insulation 		<ul style="list-style-type: none"> reflective foil perforated with holes to drain water if used under timber floors 	<ul style="list-style-type: none"> open-celled insulation (materials which store water and take a long time to dry out e.g. batts)
Bolts, hinges, fittings	<ul style="list-style-type: none"> brass, nylon/stainless steel, removable pin hinges 	<ul style="list-style-type: none"> galvanised steel aluminium 		<ul style="list-style-type: none"> mild steel
Connections – nails and screws, etc.	<ul style="list-style-type: none"> stainless steel 	<ul style="list-style-type: none"> galvanised steel 		<ul style="list-style-type: none"> mild steel
Floor coverings	<ul style="list-style-type: none"> clay and concrete tiles epoxy or cement floor toppings on concrete rubber or vinyl sheets (with chemically set adhesives) 	<ul style="list-style-type: none"> terrazzo rubber tiles (with chemically set adhesives) polished timber floor floor rugs and mats ceramic tiles 	<ul style="list-style-type: none"> loose fitting nylon or acrylic carpet (with closed cell rubber underlay) 	<ul style="list-style-type: none"> wall-to-wall carpet or seagrass matting cork linoleum timber overlay floors

Recommended materials for use with framed wall systems below storm tide level

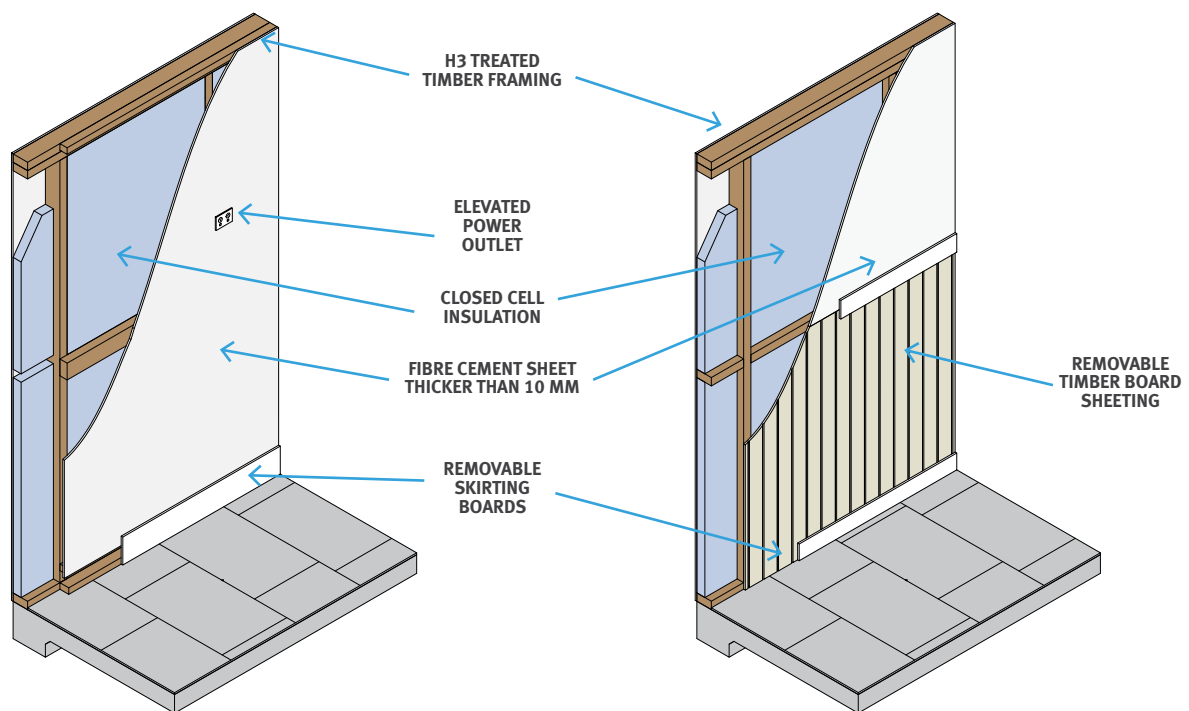

9. Improving the resilience of existing homes

The resilience of homes located in storm tide prone areas can be improved with regular maintenance or upgrades.

9.1 Maintenance

The salt-laden and moist air in coastal areas can quickly corrode metal connections, degrade concrete and accelerate the decay of timber. Homes built close to the ocean require more frequent inspection and maintenance than those built further inland.

Recommended maintenance includes hosing the house with fresh water and inspecting and replacing deteriorated members and connections. It is important to ensure that replacement connections do not trap water and that only durable materials are used. Refer to **Section 6.3** for information about corrosion resistance of metal fittings.

Checklist for maintaining homes

High-set and low-set homes on stumps

- ensure objects stored under the main habitable floor level that can impede water flow can be easily removed if required, before imminent storm tide
- check that breakaway walls can still break away cleanly from the main house
- replace corroded connections located below the main habitable floor level with corrosion resistant connections. Note: galvanised items that change colour to red or brown have reached the end of their service life.
- ensure the deck support structure and decking is in good condition and repair or replace as necessary
- check that stumps and piles are well protected from scour or erosion and repair as necessary

Two-storey slab on ground homes

- in addition to the above, check the slab edge details to ensure protection from erosion and that scour has not been compromised by landscaping.

9.2 Upgrades – general information

General recommendations for non-structural upgrades include:

- replace less resilient materials with the resilient building materials listed in **Section 8**
- relocate all electrical wiring, meter box and other installations above the adopted storm tide level
- ensure building cavities are well ventilated by making parts of the lining easily removable. E.g. use deep skirting boards to minimise rot and corrosion prior to a storm tide event and to accelerate drying out after an event.

If a home is likely to be exposed to waves during a storm tide, consider upgrading the footings and concrete slabs on ground to be more resilient to scour damage from potential storm surge. Grout injection under footings may be an affordable way of improving resistance to scour.

All structural upgrades must comply with the current requirements of the National Construction Code, which refers, to relevant Australian Standards and provide resistance to wind loads.

9.3 Upgrades for homes on stumps

Resilient measures include:

- raise the habitable floor level to above the adopted storm tide level for the location
- relocate the home to an area that is not prone to storm tide or to a higher position on the same block
- check the depth of embedment of the stumps and replace if necessary
- replace non load bearing concrete or masonry walls below floor level with breakaway walls to allow surge water and debris to flow below floor level with as little resistance as possible.

9.4 Upgrades for two–storey slab on ground homes

Resilient measures include:

- replace carpet on the lower level with tiles
- if a home is likely to be exposed to waves, replace the lower storey solid walls located parallel to the shorefront with large windows or breakaway walls.

9.5 Additions and extensions

All additions and extensions must comply with the current requirements of the National Construction Code, which refers to relevant Australian Standards. The existing home may require upgrades to ensure it doesn't compromise the addition or extension in a future storm tide event.

10. Repairing or rebuilding after a storm tide

10.1 Repairs checklist

Significant clean-up and maintenance checks are needed following a storm tide. Once the storm tide has subsided, mud and debris inside and around the home must be removed and the house should be washed thoroughly with fresh water. The following should also be considered:

Seek appropriate advice

- contact a qualified electrician to check all electrical wiring before using lights and appliances
- contact a qualified plumber to ensure waste pipes are not damaged or blocked
- contact a registered engineer if there is any sign of foundation movement or structural cracking.

Clean up

- dry out timber wall and ceiling linings, and floor boards as quickly as possible to prevent uptake of moisture, swelling and mould
- remove all mud and debris from the cavity spaces behind double brick walls or brick veneer
- replace hollow or open cell insulation e.g. batts (closed cell insulation may still be serviceable)
- remove trapped mud and debris from hidden areas such as the bottom of kitchen cupboards and bathroom vanities
- replace carpets and plasterboard wall linings with more resilient materials
- replace timber floorboards that have swelled
- ensure solid walls such as masonry and concrete are completely dry before repainting.

10.2 Reconstruction

Approval is required if your home requires demolition. Building and planning approval is also required before rebuilding (**Refer Section 11**).

The reconstructed home must comply with the current requirements of the National Construction Code whilst considering the non-mandatory resilient design principles and materials outlined in this Guide.

Finding a licensed professional

Ensure only licensed professionals are involved in the repair or rebuild of your home by checking their credentials. Visit the following websites to find a licensed professional in your area:

Licensed builders, tradespersons, and building certifiers and designers

Queensland Building and Construction Commission

www.qbcc.qld.gov.au

Licensed coastal and structural engineers

Board of Professional Engineers Queensland

www.bpeq.qld.gov.au

Licensed architects

Queensland Board of Architects

www.boaq.qld.gov.au

11. Building approvals, codes and standards

A building development approval is required from a local council or private building certifier before building a new home or upgrading and repairing an existing home.

Buildings in areas prone to cyclones should be designed in accordance with relevant Codes and Standards as indicated in this Guide. Builders should refer to a Building Certifier or local council to confirm the individual requirements for your home.

11.1 Planning approvals

A planning approval may be required for most construction work. They determine what uses and activities can occur on the land to minimise any potential impact on surrounding properties. An application for a planning approval is assessed against your council planning scheme.

11.2 Building approvals

A building development approval from a council or private building certifier is required for a new home or upgrading and repairing an existing home. A private building certifier is required to lodge the approval documents with the relevant council.

Exemptions apply for minor renovations that do not affect more than 20 per cent of the building's structural components of the same type. Refer to your local council for advice on whether a building approval is required for any planned work on your home.

Building surveyors assess the plans submitted to council to confirm they comply with the relevant codes and standards such as the National Construction Code and Queensland Development Code. This ensures that appropriate materials, products and details used in the design and construction of your home comply with the necessary standards.

A building approval is granted by a building certifier and/or your local council. The role of the Building Certifier is to confirm the proposed building complies with the relevant building codes and standards before construction can commence. They are also required during construction to inspect that the work is being built to the relevant codes and standards.

Ensure all designers, architects, builders and contractors are aware of the storm tide issues raised in this Guide.

11.3 Building Codes and Standards

New construction, major renovations and repairs all require building approval and must comply with the current Codes and Standards. Using the current Codes and Standards for any repairs or rebuilding after a cyclone and storm tide will also give your home the best chance of performing well and safeguarding the lives of you and your family during future cyclones.

The following Codes and Standards may be used by your designer or builder:

1. National Construction Code; Volume 2: Building Code of Australia, Class 1 and Class 10 Buildings, Australian Building Codes Board, Canberra.
2. AS/NZS 1170.2 Structural design actions Part 2: Wind actions. Standards Australia, Sydney NSW, Australia.
3. AS 4055 Wind Loads for Housing. Standards Australia, Sydney, NSW.
4. AS 1684.3 Residential timber-framed construction – Cyclonic areas. Standards Australia, Sydney, NSW, Australia.
5. HB 39 Installation code for metal roof and wall cladding. Standards Australia, Sydney, NSW.
6. AS 2050 Installation of roof tiles. Standards Australia, Sydney, NSW.
7. HB 132.2 Structural upgrading of older houses - Part 2: Cyclone areas. Standards Australia, Sydney, NSW.
8. AS/NZS 4505 Garage doors and other large access doors Standards Australia, Sydney, NSW.

12. Definitions

Astronomical tide	The periodic rise and fall of the oceans, resulting from the gravitational attraction of the moon, sun and other astronomical bodies acting upon the rotating earth.
Australian Height Datum (AHD)	Australian Height Datum is the datum (adopted by the National Mapping Council of Australia) to which all vertical control for topographic mapping is to be referred. AHD is close to Mean Sea Level on an open coast.
Annual Exceedance Probability (AEP)	The AEP is normally expressed as a percentage and refers to the probability of an event (flood, wind or storm tide) of the nominated magnitude or larger occurring in any given year. For example, a 1% AEP describes an event that has a 1 in 100 chance of being equalled or exceeded in any given year and a ten per cent chance of occurring in any ten year period.
Coastal engineer	A Registered Professional Engineer Queensland (RPEQ) with specialist expertise in coastal processes.
Highest Astronomical Tide (HAT)	The highest water level predicted to occur under average meteorological conditions and any combination of astronomical conditions.
Lowest Astronomical Tide (LAT)	The lowest water level predicted to occur under average meteorological conditions and any combination of astronomical conditions. Tide tables are referenced to LAT in Queensland and typically refers to “Chart Datum”.
Mean sea level	A tidal datum; the arithmetic mean of hourly heights of the sea at the tidal station observed over a period of time (preferably at least 19 years).
Storm surge	A localised increase (or decrease) in ocean water levels caused by high winds and reduced atmospheric pressures associated with a severe storm event.
Storm tide	The effect on coastal water of a storm surge and associated breaking wave set-up combined with the normally occurring astronomical tide.
Storm tide inundation area	The area of land determined to be at risk from inundation associated with a storm tide.
Defined Storm Tide Event (DSTE)	The event (measured in terms of likelihood of recurrence) and associated inundation level adopted to manage the development of a particular area. The defined storm tide event is the 1% AEP storm tide unless otherwise indicated for essential community service infrastructure.
Breaking Wave Set-up	An increase in the mean water level towards the shoreline caused by breaking wave action. It can be very important during storm events as it results in a further increase in water level above the tide and surge levels.
Stillwater Level	The average coastal water level ignoring the presence of intermittent passing waves.

13. Resources

Useful links for homeowners

Bureau of Meteorology
Australian Government
www.bom.gov.au

Rebuilding after a disaster
Queensland Building and Construction Commission
www.qbcc.qld.gov.au/home-maintenance/rebuilding-after-natural-disaster

Cyclone Testing Station videos on building, maintaining and renovating houses in cyclone areas
www.jcu.edu.au/cyclone-testing-station/videos-And-resources/for-the-home-owner-And-occupier

Housing and Public Works – Building Legislation and Policy
<https://www.hpw.qld.gov.au/services/building-plumbing>

Technical resources – Queensland specific

Cyclone Testing Station Technical Reports

James Cook University

www.jcu.edu.au/cyclone-testing-station/research/reports

Natural Disaster Resilience Program Storm Tide Hazard Interpolation Series

Department of Environment and Science

www.data.qld.gov.au/dataset/ndrp-storm-tide-hazard-interpolation-series

Coastal Hazards and Mapping

Department of Environment and Science

www.qld.gov.au/environment/coasts-waterways/plans/hazards

Storm tide monitoring sites in Queensland

Department of Environment and Science

www.qld.gov.au/environment/coasts-waterways/beach/storm/storm-sites

National Committee on Coastal and Ocean Engineering - Publications and resources

Engineers Australia

www.engineersaustralia.org.au/Communities-And-Groups/National-Committees-And-Panels/Coastal-And-Ocean-Engineering/Publications-Resources

Queensland Climate Change and Community Vulnerability to Tropical Cyclones – Ocean Hazards Assessment – stage 1 report, March 2001

Queensland Government

www.data.longpaddock.qld.gov.au/static/publications/vulnerability-to-cyclones/stage1.pdf

Guidelines for Responding to the Effects of Climate Change in Coastal and Ocean Engineering

Engineers Australia

www.eabooks.com.au/Guidelines-for-Responding-to-the-Effects-of-Climate-Change-in-Coastal-and-Ocean-Engineering

Technical resources – international

US Geological Survey

www.coastal.er.usgs.gov/hurricanes/ike/photo-comparisons/bolivar.html

US Federal Emergency Management Agency

www.fema.gov/media-library/assets/documents/3293

FEMA Coastal Construction Manual Volume II

US Federal Emergency Management Agency

www.fema.gov/media-library-data/20130726-1510-20490-1986/fema55_volii_combined_rev.pdf



For more information

-  www.qra.qld.gov.au/Resilient-Homes
-  info@qra.qld.gov.au
-  1800 110 841